

2009 *FIRST* Robotics Competition

Sensor Manual

The 2009 *FIRST* Robotics Competition (FRC) sensors are outlined in this document. It is being provided as a courtesy, and therefore does not supersede any information or rules provided in the 2009 *FIRST* Robotics Competition Manual.

Small, Low Power, 3-Axis ± 3 g Accelerometer (Analog Devices PN ADXL335)



The 3-Axis Accelerometer measures both dynamic motion (vibration) and static motion (gravity). Accelerometers are sensitive to rough handling. Please remember to handle with care.

To use this sensor with your new control system, connect the outputs for the axes you wish to measure (X_{out} , Y_{out} , Z_{out} , or a combination of the three) to the analog input pins on your Analog Breakout. You can solder RC Extension cables to the board to transmit signal, 5V supply, and ground. Alternatively, you may create your own wiring harness using 22AWG wire.

The circuit card assembly is designed to permit standoff mounting using appropriate hardware. Note that plastic hardware should be used to isolate the PCB from chassis contact. There are 4-40 clearance holes at (0.200",0.800") and (0.800",0.200"). The board is 1"x1".

The performance specifications are all included in the data sheet posted on the Analog Devices website at www.analog.com. Please note that while the Analog Breakout supplies 5V to the board, the circuit card assembly steps the supply voltage to the ADXL335 down to 3V. Please see the schematic for further details.

The orientation of the chip is indicated by the silkscreen on the circuit card assembly.

The ADXL335 can measure $\pm 3g$ in each axis. Nominal output is 1.5V at 0g (free-fall), plus 300mV/g. Each axis has a single pole low-pass filter set to 225Hz: Teams are encouraged to experiment with digital filters in order to select a bandwidth appropriate for their specific usage.

For detailed operation of the Analog Devices [ADXL335](http://www.analog.com) accelerometer, refer to the [datasheet](http://www.analog.com) which can be found on the Analog Devices website at www.analog.com. Please refer to the datasheet for tolerances and other specs.

Yaw Rate Gyro (Analog Devices PN AD22305)



The angular rate sensor (gyroscope) senses angular changes about the top surface axis of the device and provides an output voltage proportional to the angular rate change. The output is useful for guidance, stability, and control of the robot platform. The lowest apparent drift on the gyro will occur when the module is mounted flat in or near the center axis of the robots rotation.

The PCB modules are designed to permit standoff mounting using appropriate hardware. Note that plastic fasteners should always be used to isolate the PCB from chassis contact. The mounting footprint is the same for both the gyro and the accelerometer carrier boards.

The AD22305 can measure up to $250^{\circ}/s$ of rotation. Nominal output is 2.5V at standstill, plus $7mV/^{\circ}/s$. The carrier board adds a double pole low-pass filter set to 400Hz: Teams are encouraged to experiment with digital filters in order to select a bandwidth appropriate for their specific usage.

The AD22305 has an integrated temperature sensor to assist in temperature compensation. Nominal output is 2.5V at $25^{\circ}C$ plus $9mV/^{\circ}C$.

The datasheet is not available online, but is attached to this document for reference. Please refer to the datasheet for tolerances and other specs.



FEATURES

- Complete rate gyroscope on a single chip
- Z-axis (yaw rate) response
- High vibration rejection over wide frequency
- 2000 g powered shock survivability
- Ratiometric to referenced supply
- 5 V single-supply operation
- 105°C operation
- Self-test on digital command
- Ultrasmall and light (< 0.15 cc, < 0.5 gram)
- Temperature sensor output
- RoHS Compliant

APPLICATIONS

- Vehicle chassis rollover sensing
- Vehicle yaw/roll stability control
- Inertial measurement units
- Platform stabilization

GENERAL DESCRIPTION

The AD22305 is a complete angular rate sensor (gyroscope) that uses Analog Devices' surface-micromachining process to make a functionally complete and low cost angular rate sensor integrated with all of the required electronics on one chip. The manufacturing technique for this device is the same high volume BIMOS process used for high reliability automotive airbag accelerometers.

The output signal, RATEOUT (1B, 2A), is a voltage proportional to angular rate about the axis normal to the top surface of the package. The output is ratiometric with respect to a provided reference supply. A single external resistor can be used to lower the scale factor. An external capacitor is used to set the bandwidth. Other external capacitors are required for operation.

A temperature output is provided for compensation techniques. Two digital self-test inputs electromechanically excite the sensor to test proper operation of both the sensor and the signal conditioning circuits. The AD22305 is available in a 7 mm × 7 mm × 3 mm BGA chip-scale package.

FUNCTIONAL BLOCK DIAGRAM

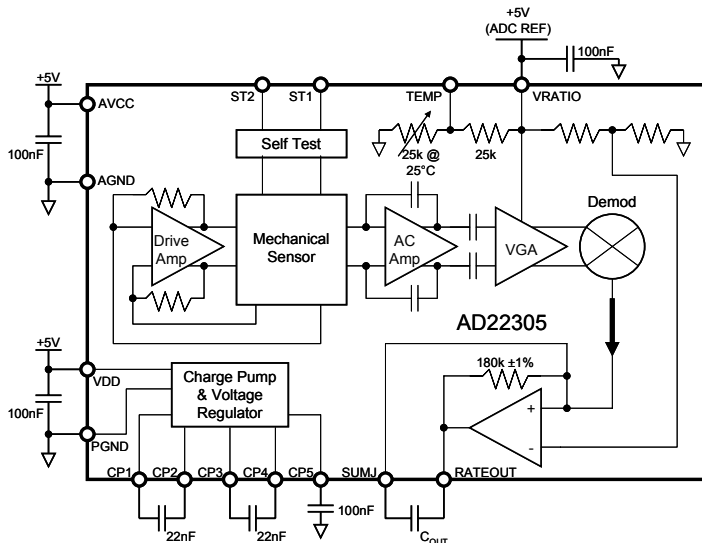

Figure 1. AD22305 Block Diagram

Rev. G

Information furnished by Analog Devices is believed to be accurate and reliable. However, no responsibility is assumed by Analog Devices for its use, nor for any infringements of patents or other rights of third parties that may result from its use. Specifications subject to change without notice. No license is granted by implication or otherwise under any patent or patent rights of Analog Devices. Trademarks and registered trademarks are the property of their respective owners.

One Technology Way, P.O. Box 9106, Norwood, MA 02062-9106, U.S.A.

Tel: 781.329.4700

www.analog.com

Fax: 781.326.8703 © 2004 Analog Devices, Inc. All rights reserved.

TABLE OF CONTENTS

Specifications	3	Calibrated Performance	10
Absolute Maximum Ratings.....	5	AD22305 and Supply Ratiometricity	11
Rate Sensitive Axis.....	5	Null Adjustment	11
Calibration data	6	Self-Test Function	11
ESD Caution.....	6	Continuous Self-Test	11
Typical Performance Characteristics	7	Pin Configuration and Function Descriptions	12
Theory of Operation	10	Outline Dimensions	13
Setting Bandwidth	10	Ordering Guide.....	13
Temperature Output and Calibration	10		

REVISION HISTORY**7/08 – Rev. F to Rev. G**

Added RoHS compliant marker to ordering guide.....Page 13
Fixed Ordering guide descriptions.....Page 13

7/08 – Rev. E to Rev. F

Added AD22305Z2-RL to order guide.....Page 13

6/08 – Rev. D to Rev. E

Changed cal coef table and paragraph.....Page 6

12/07 – Rev. C to Rev. D

Corrected order guide.....Page 10

11/07 – Rev. B to Rev. C

Cross axis sensitivity specification added.....Page 3

10/07 – Rev. A to Rev. B

Part number suffixes added to order guide.....Page 10

11/06 – Rev. 0 to Rev. A

Typos fixed.....Page 10
Added capacitor values to Table 5.....Page 12

10/06 - Revision 0: Initial Version

SPECIFICATIONS

All minimum and maximum specifications are guaranteed. Typical specifications are not guaranteed.

@ $T_A = -40^{\circ}\text{C}$ to $+105^{\circ}\text{C}$, $V_S=AV_{CC}=V_{DD}=5\text{V}$, $V_{\text{RATIO}}=AV_{CC}$, Angular Rate = $0^{\circ}/\text{s}$, Bandwidth = 80 Hz ($C_{\text{OUT}} = 0.01 \mu\text{F}$), $I_{\text{OUT}}=100\mu\text{A}$, $\pm 1g$, unless otherwise noted.

Table 1.

Parameter	Conditions	AD22305			Unit
		Min	Typ	Max	
SENSITIVITY⁷					
Measurement Range ¹	Clockwise rotation is positive output	± 250			$^{\circ}/\text{s}$
Initial and Over Temperature	Full-scale range over specifications range	6.2	7	7.8	$\text{mV}/^{\circ}\text{s}$
Temperature Drift ²			± 2		%
Calibrated Sensitivity Error ³				± 2	%
Cross Axis Sensitivity			± 1	± 3	%
Nonlinearity	Best fit straight line		0.1		% of FS
NULL⁷					
Null	-40°C to $+105^{\circ}\text{C}$	2.175	2.5	2.825	V
Calibrated Null ³				± 3	$^{\circ}/\text{s}$
Linear Acceleration Effect	Any axis		0.1		$^{\circ}/\text{s}/g$
NOISE PERFORMANCE					
Rate Noise Density	$T_A \leq 25^{\circ}\text{C}$		0.03		$^{\circ}/\text{s}/\sqrt{\text{Hz}}$
Rate Noise Density	$T_A \leq 85^{\circ}\text{C}$			0.06	$^{\circ}/\text{s}/\sqrt{\text{Hz}}$
FREQUENCY RESPONSE					
Bandwidth ⁴		0.01		2500	Hz
Sensor Resonant Frequency		12	14.5	17	kHz
SELF-TEST					
ST1 RATEOUT Response ⁷	ST1 pin from Logic 0 to 1	-725	-525	-325	mV
ST2 RATEOUT Response ⁷	ST2 pin from Logic 0 to 1	325	525	725	mV
Calibrated ST1 Error ³		-25		25	mV
Calibrated ST2 Error ³		-25		25	mV
ST1 – ST2 Mismatch ⁶		-5	± 1	5	%
Logic 1 Input Voltage ⁷		3.3			V
Logic 0 Input Voltage ⁷				1.7	V
Input Impedance	To common	40	50	100	k Ω
TEMPERATURE SENSOR⁷					
V_{OUT} at 25°C	Load > 100M	2.35	2.5	2.65	V
Scale Factor ⁵	@ 25°C , $V_{\text{RATIO}}=5\text{V}$		9		$\text{mV}/^{\circ}\text{C}$
Calibrated Temperature Error		-6		+6	$^{\circ}\text{C}$
Load to V_S			25		k Ω
Load to Common			25		k Ω

(Table Continued on Next Page)

AD22305

Turn-On Turn-On Time	Power on to $\pm 1/2^{\circ}$ /s of final	50	ms
OUTPUT DRIVE CAPABILITY Current Drive Capacitive Load Drive	For rated specifications	200 1000	μ A pF
POWER SUPPLY Operating Voltage (V_S) Quiescent Supply Current		4.85 5.00 5.15 3.5 4.5	V mA
TEMPERATURE RANGE Specified Performance		-40 +105	$^{\circ}$ C

¹ Measurement range is the maximum range possible, including output swing range, initial offset, sensitivity, offset drift, and sensitivity drift at 5 V supplies.

² From 25 $^{\circ}$ C to -40 $^{\circ}$ C or 25 $^{\circ}$ C to 105 $^{\circ}$ C

³ Calibrated performance (using supplied calibration data) is based on characterization and not production tested.

⁴ Adjusted by external capacitor C_{OUT} . Reducing bandwidth below 0.01Hz will not result in further noise improvement.

⁵ Scale factor for a change in temperature from 25 $^{\circ}$ C to 26 $^{\circ}$ C. V_{TEMP} is ratiometric to V_{RATIO} . See the Temperature Sensor section for more details.

⁶ Self test mismatch is described as $(ST2+ST1) / ((ST2-ST1) / 2)$.

⁷ Parameter is linearly ratiometric with V_{RATIO} .

ABSOLUTE MAXIMUM RATINGS

Table 2.

Parameter	Rating
Acceleration (Any Axis, Unpowered, 0.5 ms)	2000g
Acceleration (Any Axis, Powered, 0.5 ms)	2000g
+V _{DD} , +AV _{CC}	-0.3V to +6.0V
V _{RATIO}	AV _{CC}
ST1, ST2	AV _{CC}
Output Short-Circuit Duration (Any Pin to Common)	Indefinite
Operating Temperature Range	-55°C to +125°C
Storage Temperature	-65°C to +150°C

Stresses above those listed under the Absolute Maximum Ratings may cause permanent damage to the device. This is a stress rating only; functional operation of the device at these or any other conditions above those indicated in the operational section of this specification is not implied. Exposure to absolute maximum rating conditions for extended periods may affect device reliability.

Drops onto hard surfaces can cause shocks of greater than 2000 g and exceed the absolute maximum rating of the device. Care should be exercised in handling to avoid damage.

RATE SENSITIVE AXIS

This is a Z-axis rate-sensing device (also called a yaw rate sensing device). It produces a positive going output voltage for clockwise rotation about the axis normal to the package top, i.e., clockwise when looking down at the package lid.

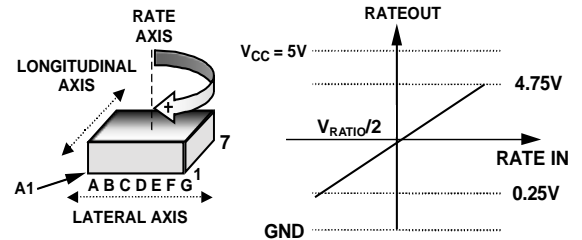

Figure 2. RATEOUT Signal Increases with Clockwise Rotation

CALIBRATION DATA

ADI provides calibration information for each uniquely serialized part. Calibration information is provided for the following key parameters:

- Null
- Self-Test 1
- Self-Test 2
- Sensitivity

For each of the above parameters, at least the following information is provided:

- Initial Value at Temperature T_0
- A Coefficient (Linear Term)
- B Coefficient (Quadratic Term)

In addition, the temperature sensor output voltage at T_0 is also provided so that calibration can be performed according to:

$$V_{CAL} = V_{T_0} + A(V_{TEMP@T_1} - V_{TEMP@T_0}) + B(V_{TEMP@T_1} - V_{TEMP@T_0})^2$$

Minimum and maximum values for all A and B coefficients are shown in Table 3.

Additionally, ADI also provides calibration data used to establish temperature, in degrees C, from the sensor V_{TEMP} voltage output by:

$$\text{Temperature} = \text{Temp}_a(V_{TEMP@T})^2 + \text{Temp}_b(V_{TEMP@T}) + \text{Temp}_c$$

Table 3 also includes minimum and maximum values for these calibration coefficients.

Complete details on calibration are provided in a separate application note.

Table 3. Minimum/Maximum Coefficient Values

Parameter	Units	Minimum	Maximum
Null A	Volts / Volt	-0.35	0.35
Null B	Volts / Volt ²	-0.15	0.15
ST1 A	Volts / Volt	-0.185	-0.08
ST1 B	Volts / Volt ²	-0.04	0.04
ST2 A	Volts / Volt	0.08	0.185
ST2 B	Volts / Volt ²	-0.04	0.04
Sensitivity A	milliVolts / ° / s / Volt	-0.6	0.5
Sensitivity B	milliVolts / ° / s / Volt ²	-0.35	0.2
Temp_a	°C / Volts ²	-6.0	100.0
Temp_b	°C / Volts	-55.0	140.0
Temp_c	°C	-1000.0	0.0

ESD CAUTION

ESD (electrostatic discharge) sensitive device. Electrostatic charges as high as 4000 V readily accumulate on the human body and test equipment and can discharge without detection. Although this product features proprietary ESD protection circuitry, permanent damage may occur on devices subjected to high energy electrostatic discharges. Therefore, proper ESD precautions are recommended to avoid performance degradation or loss of functionality.



TYPICAL PERFORMANCE CHARACTERISTICS

N > 1000 for all typical performance plots, unless otherwise noted

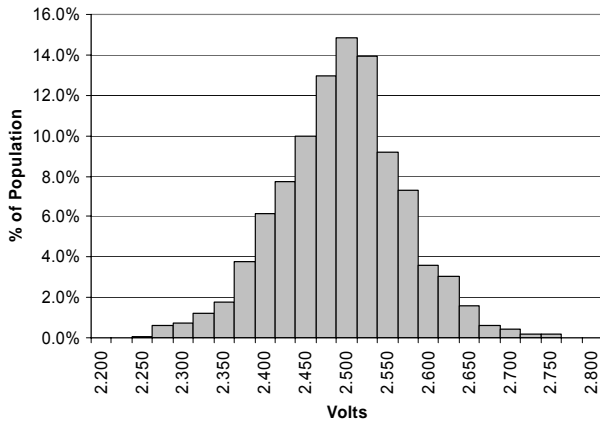

Figure 3. Null Output at 25°C – $V_{RATIO}=5V$

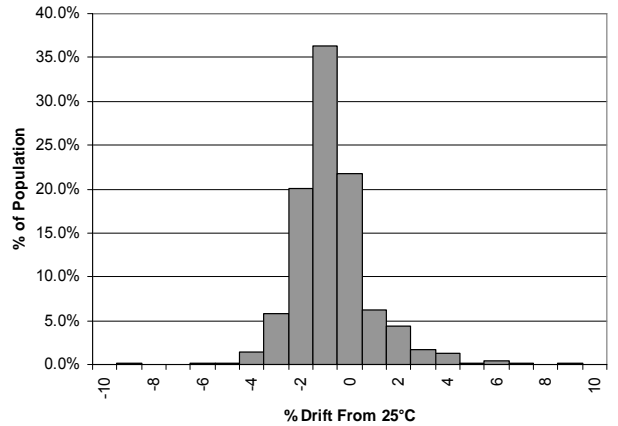

Figure 6. Sensitivity Drift Over Temperature

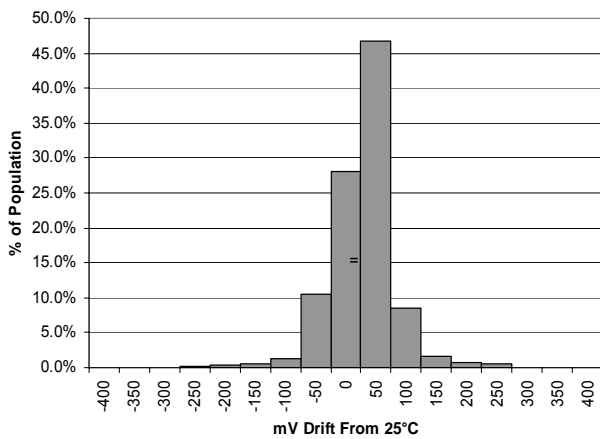

Figure 4. Null Drift Over Temperature ($V_{RATIO}=5V$)

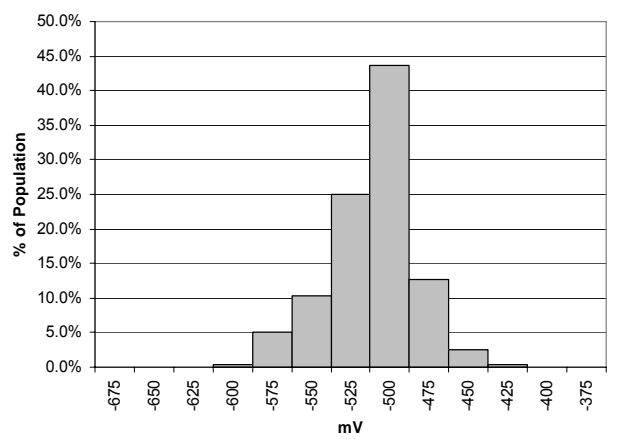

Figure 7. ST1 Output change at 25°C ($V_{RATIO}=5V$)

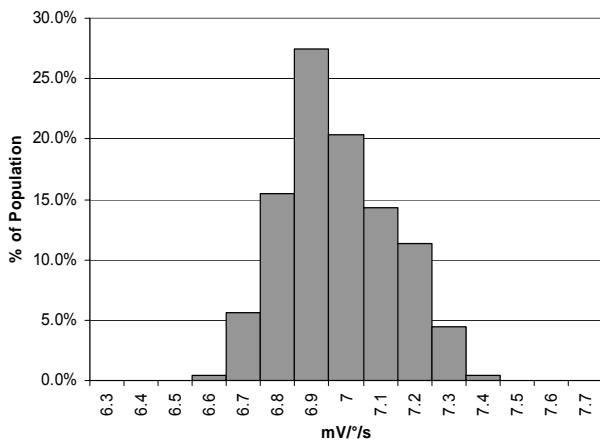

Figure 5. Sensitivity at 25°C ($V_{RATIO}=5V$)

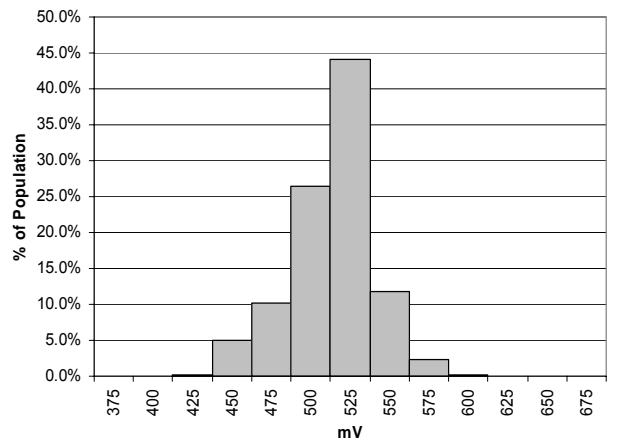

Figure 8. ST2 Output change at 25°C ($V_{RATIO}=5V$)

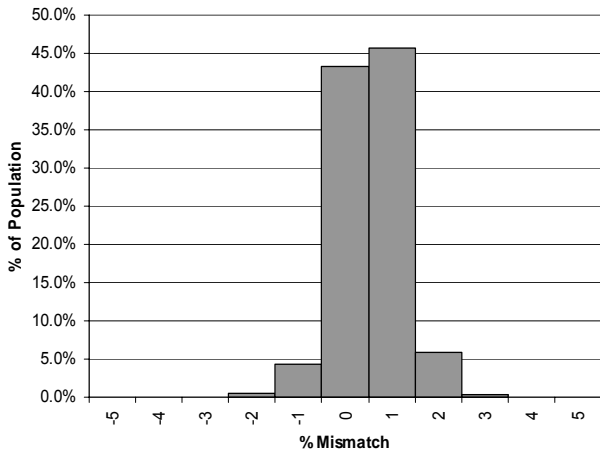

Figure 9. Self Test Mismatch at 25°C (V_{RATIO}=5V)

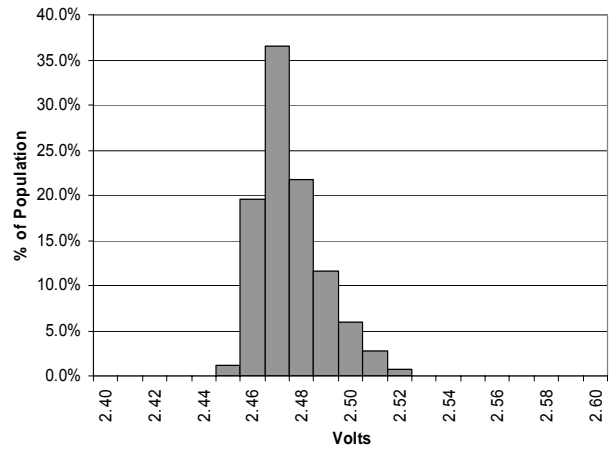

Figure 12. V_{TEMP} Output at 25°C (V_{RATIO}=5V)

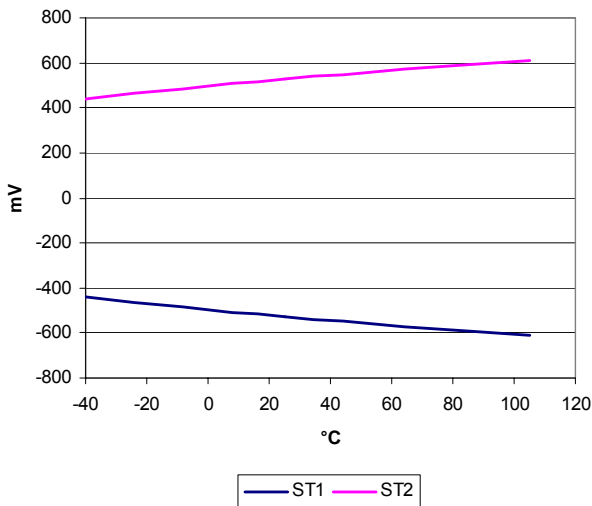

Figure 10. Typical Self Test Change Over Temperature

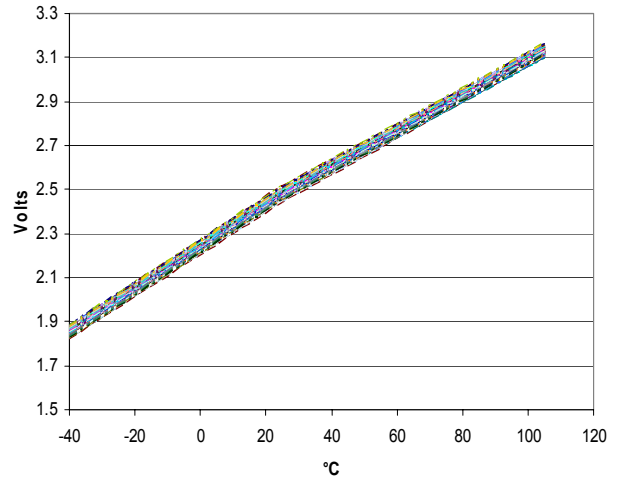

Figure 13. V_{TEMP} Output Over Temperature- 256 Parts (V_{RATIO}=5V)

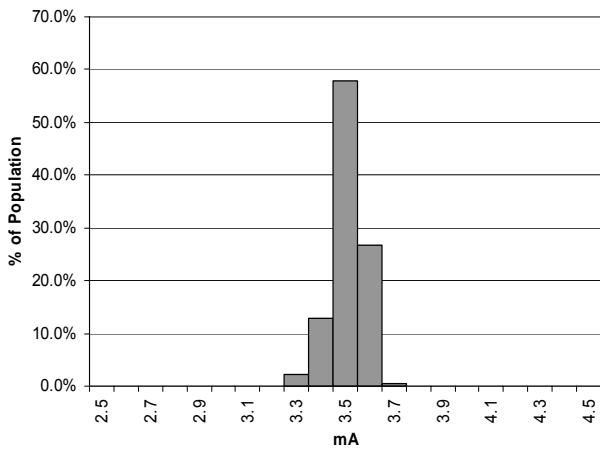

Figure 11. Current Consumption at 25°C (V_{RATIO}=5V)

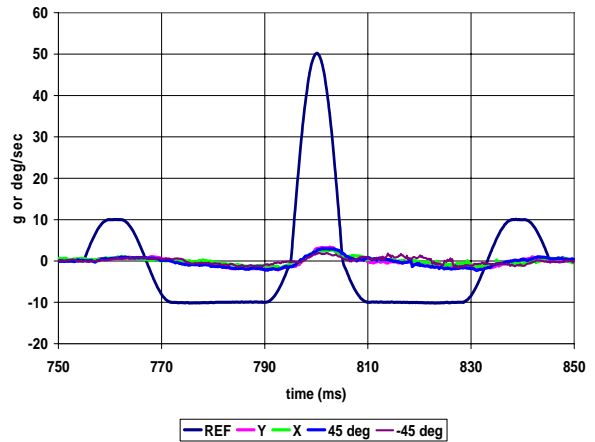

Figure 14. g and g x g Sensitivity for a 50g, 10ms Pulse

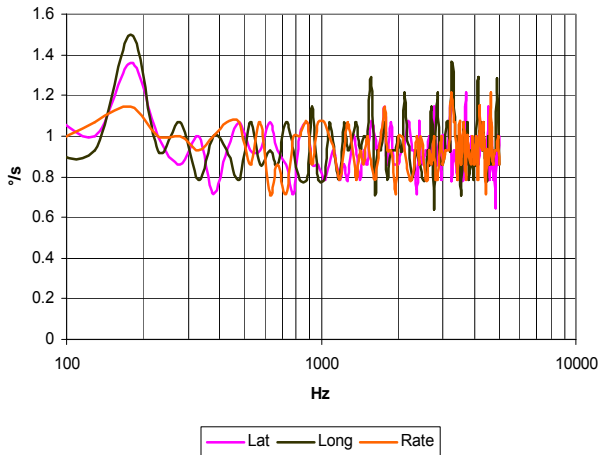

Figure 15. Typical Response to 10g Sinusoidal Vibration (Sensor Bandwidth = 2kHz)

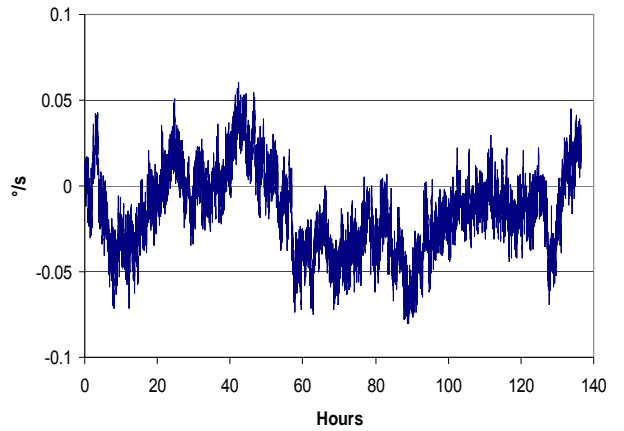

Figure 18. Typical Shift in 90 s Null Averages Accumulated Over 140 hours

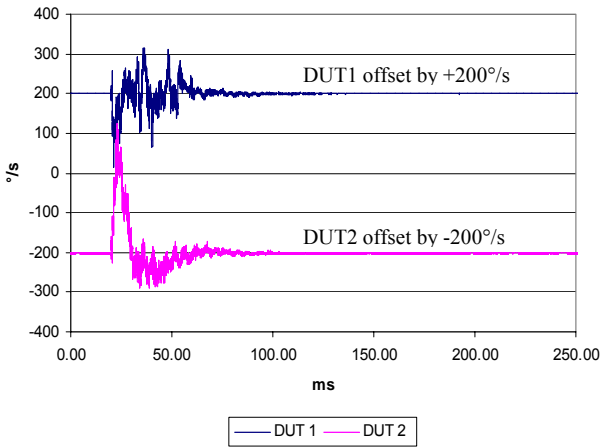

Figure 16. Typical High g (2500g) Shock Response (Sensor Bandwidth = 40Hz)

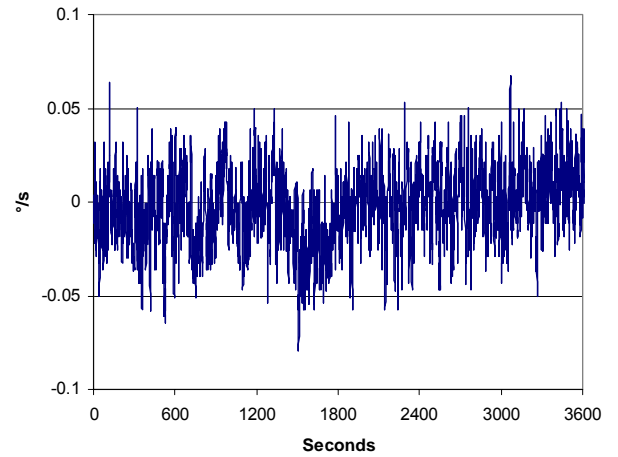

Figure 19. Typical Shift in Short Term Null (Bandwidth = 1 Hz)

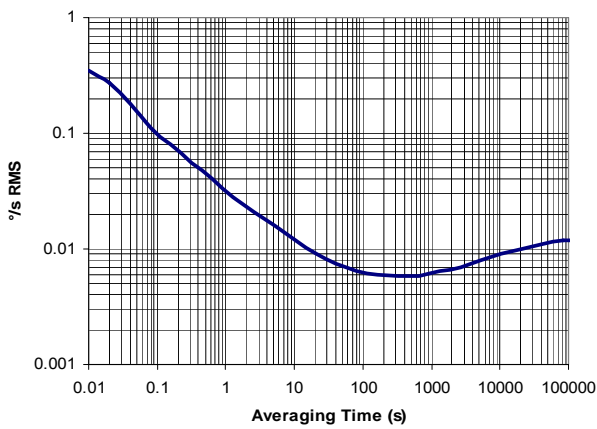

Figure 17. Typical Root Allan Variance at 25°C vs. Averaging Time

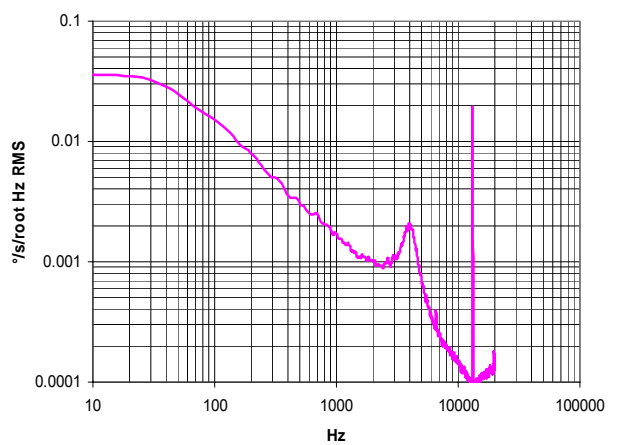

Figure 20. Typical Noise Spectral Density (Bandwidth = 40Hz)

THEORY OF OPERATION

The AD22305 operates on the principle of a resonator gyro. Two polysilicon sensing structures each contain a dither frame, which is electrostatically driven to resonance. This produces the necessary velocity element to produce a Coriolis force during angular rate. At two of the outer extremes of each frame, orthogonal to the dither motion, are movable fingers that are placed between fixed pickoff fingers to form a capacitive pickoff structure that senses Coriolis motion. The resulting signal is fed to a series of gain and demodulation stages that produce the electrical rate signal output. The dual-sensor design rejects external g-forces and vibration. Fabricating the sensor with the signal conditioning electronics preserves signal integrity in noisy environments.

The electrostatic resonator requires 18 V to 20 V for operation. Since only 5 V is typically available in most applications, a charge pump is included on-chip. If an external 18 V to 20 V supply is available, the two capacitors on CP1–CP4 can be omitted and this supply can be connected to CP5 (Pin 7D). CP5 should not be grounded when power is applied to the AD22305. No damage will occur, but under certain conditions the charge pump may fail to start up after the ground is removed without first removing power from the AD22305.

SETTING BANDWIDTH

External capacitor C_{OUT} is used in combination with the on-chip R_{OUT} resistor to create a low-pass filter to limit the bandwidth of the AD22305's rate response. The -3 dB frequency set by R_{OUT} and C_{OUT} is:

$$f_{OUT} = 1 / (2 \times \pi \times R_{OUT} \times C_{OUT})$$

and can be well controlled since R_{OUT} has been trimmed during manufacturing to be $180 \text{ k}\Omega \pm 1\%$. Any external resistor applied between the RATEOUT (1B, 2A) and SUMJ (1C, 2C) pins will result in:

$$R_{OUT} = (180 \text{ k}\Omega \times R_{EXT}) / (180 \text{ k}\Omega + R_{EXT})$$

In general, an additional filter (either in hardware or software) is added to attenuate high frequency noise arising from demodulation spikes at the gyro's 14kHz resonant frequency (the noise spikes at 14kHz can be clearly seen in the power spectral density curve shown in Figure 20). Normally this additional filter's corner frequency is set to greater than 5 times the required bandwidth so as to preserve good phase response.

Figure 21 shows the effect of adding a 250Hz filter to the output of an AD22305 set to 40Hz bandwidth (as shown in Figure 20). High frequency demodulation artifacts are attenuated by approximately 18db.

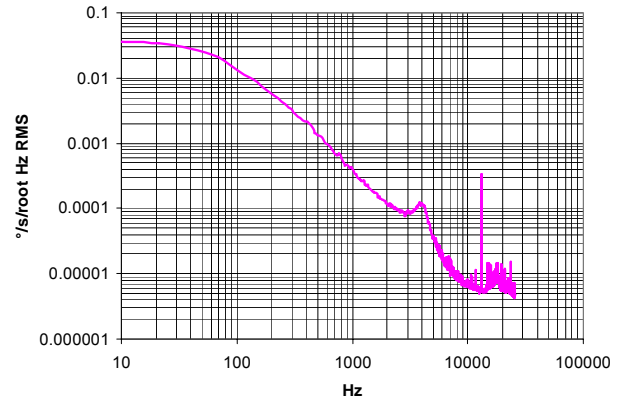

Figure 21. Noise Spectral Density with Additional 250Hz Filter

TEMPERATURE OUTPUT AND CALIBRATION

It is common practice to temperature-calibrate gyros to improve their overall accuracy. The AD22305 has a temperature proportional voltage output that provides input to such a calibration method. The temperature sensor structure is shown in Figure 22. The temperature output is characteristically non-linear, and any load resistance connected to the TEMP output will result in decreasing the TEMP output and its temperature coefficient. Therefore buffering the output is recommended.

The voltage at TEMP (3F, 3G) is nominally 2.5 V at 25°C and $V_{RATIO}=5V$. The temperature coefficient is $\sim 9 \text{ mV}/^\circ\text{C}$ at 25°C. While the TEMP output is highly repeatable, it has only modest absolute accuracy. Even using the supplied calibration information for correction of the temperature sensor will result in best case absolute accuracy of no better than $\pm 6^\circ\text{C}$.

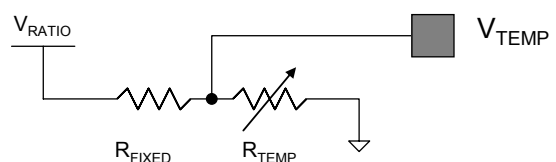

Figure 22. AD22305 Temperature Sensor Structure

CALIBRATED PERFORMANCE

Using a 3-point calibration technique, it is possible to calibrate the AD22305's null and sensitivity drift to an overall accuracy

of nearly 200°/hour. An overall accuracy of 40°/hour or better is possible using more points. Limiting the bandwidth of the device reduces the flat-band noise during the calibration process, improving the measurement accuracy at each calibration point.

AD22305 AND SUPPLY RATIOMETRICITY

The AD22305's RATEOUT, ST1, ST2, and TEMP signals are ratiometric to the V_{RATIO} voltage, i.e., the null voltage, rate sensitivity, and temperature outputs are proportional to V_{RATIO} . So the AD22305 is most easily used with a supply-ratiometric ADC which results in self cancellation of errors due to minor supply variations. There is some small error due to non-ratiometric behavior. Typical ratiometricity error for null, sensitivity, self-test, and temperature output are outlined in Table 4.

Note that V_{RATIO} must never be greater than AV_{CC}

Table 4. Ratiometricity Error for Various Parameters

Parameter	$V_S = V_{\text{RATIO}} = 4.85\text{V}$	$V_S = V_{\text{RATIO}} = 5.15\text{V}$
ST1	Mean = -0.4%	Mean = -0.3%
	Sigma = 0.6%	Sigma = 0.6%
ST2	Mean = -0.4%	Mean = -0.3%
	Sigma = 0.6%	Sigma = 0.6%
Null	Mean = -0.04%	Mean = -0.02%
	Sigma = 0.3%	Sigma = 0.2%
Sensitivity	Mean = 0.03%	Mean = 0.1%
	Sigma = 0.1%	Sigma = 0.1%
V_{TEMP}	Mean = -0.3%	Mean = -0.5%
	Sigma = 0.1%	Sigma = 0.1%

NULL ADJUSTMENT

The nominal 2.5 V null is for a symmetrical swing range at

RATEOUT (1B, 2A). However, a nonsymmetric output swing may be suitable in some applications. Null adjustment is possible by injecting a suitable current to SUMJ (1C, 2C). Note that supply disturbances may reflect some null instability. Digital supply noise should be avoided particularly in this case.

SELF-TEST FUNCTION

The AD22305 includes a self-test feature that actuates each of the sensing structures and associated electronics in the same manner as if subjected to angular rate. It is activated by standard logic high levels applied to inputs ST1 (5F, 5G), ST2 (4F, 4G), or both. ST1 will cause the voltage at RATEOUT to change about

-0.5 V and ST2 will cause an opposite change of +0.5 V. The self-test response follows the viscosity temperature dependence of the package atmosphere, approximately 0.25%/°C, as shown in Figure 10.

Activating both ST1 and ST2 simultaneously is not damaging. ST1 and ST2 are fairly closely matched ($\pm 1\%$ typically), but actuating both simultaneously may result in a small apparent null bias shift proportional to the degree of self test mismatch.

ST1 and ST2 are activated by applying a voltage equal to V_{RATIO} to the ST1 and ST2 pins. The voltage applied to ST1 and ST2 must never be greater than AV_{CC} .

CONTINUOUS SELF-TEST

The one-chip integration of the AD22305 gives it higher reliability than is obtainable with any other high volume manufacturing method. Also, it is manufactured under a mature BIMOS process that has field-proven reliability. As an additional failure detection measure, power-on self-test can be performed. However, some applications may warrant continuous self-test while sensing rate. Details outlining continuous self-test techniques are also available in a separate Application Note.

PIN CONFIGURATION AND FUNCTION DESCRIPTIONS

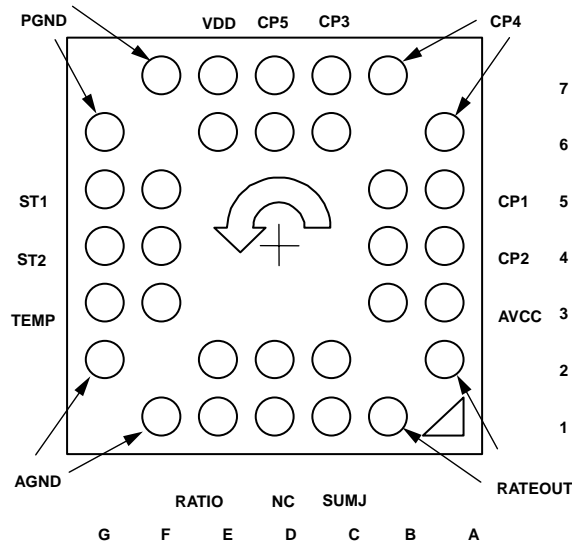

Figure 23. 32-Lead BGA (Bottom View)

Table 5. Pin Function Descriptions

Pin No.	Mnemonic	Description
6D, 7D	CP5	HV Filter Capacitor – 0.1 μ F
6A, 7B	CP4	Charge Pump Capacitor – 22nF
6C, 7C	CP3	
5A, 5B	CP1	Charge Pump Capacitor – 22nF
4A, 4B	CP2	
3A, 3B	AVCC	+ Analog Supply
1B, 2A	RATEOUT	Rate Signal Output
1C, 2C	SUMJ	Output Amp Summing Junction
1D, 2D	NC	
1E, 2E	VRATIO	Reference Supply for Ratiometric Output
1F, 2G	AGND	Analog Supply Return
3F, 3G	TEMP	Temperature Voltage Output
4F, 4G	ST2	Self-Test for Sensor 2
5F, 5G	ST1	Self-Test for Sensor 1
6G, 7F	PGND	Charge Pump Supply Return
6E, 7E	VDD	+ Charge Pump Supply

OUTLINE DIMENSIONS

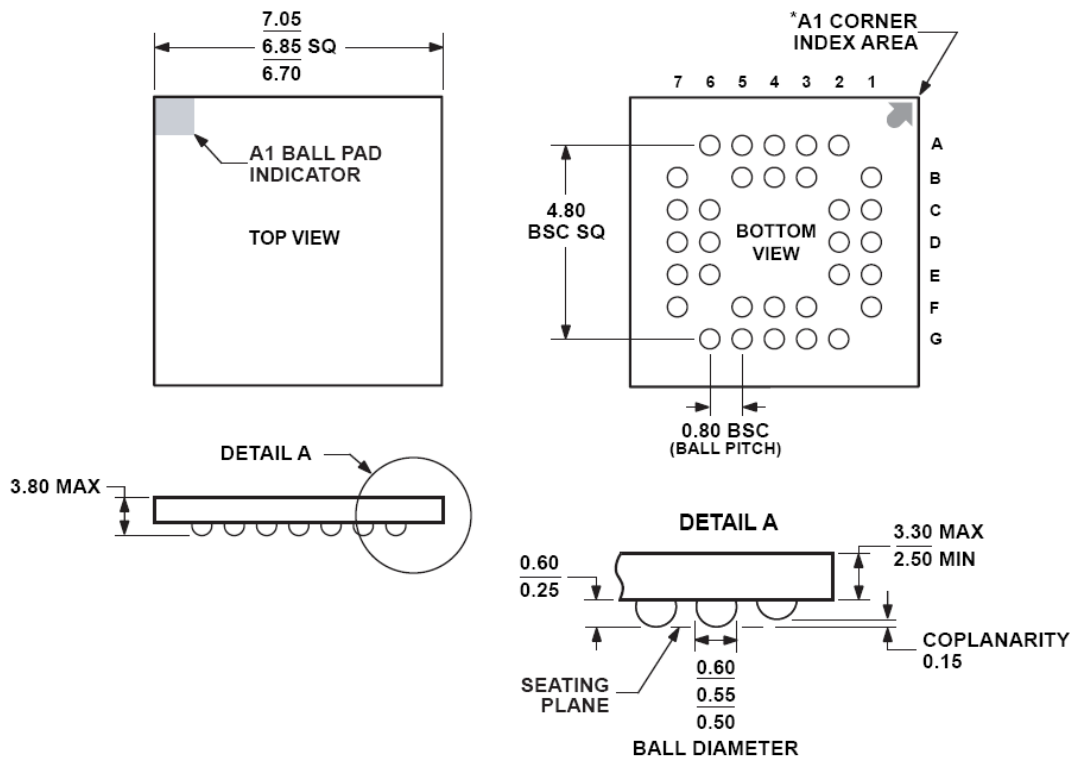

Figure 24. 32-Lead Chip Scale Ball Grid Array [CSPBGA]
(BC-32)
Dimensions shown in millimeters

ORDERING GUIDE

Model	Temperature Range	Package Description	Package Outline
AD22305Z ¹	-40°C to +105°C	32-Lead BGA	BC-32
AD22305Z ¹ -RL	-40°C to +105°C	32-Lead BGA	BC-32
AD22305Z1 ¹ -RL	-40°C to +105°C	32-Lead BGA with Cairo Cal File, new Vtemp format	BC-32
AD22305Z2 ¹ -RL	-40°C to +105°C	32-Lead BGA – AD22305Z1 with Sintered Lid	BC-32

¹ Z = RoHS Compliant Part.